



Patriot Titan II 24 FHD

User Guide

Version 3
English 07/2024

Many people who suffer from macular degeneration, glaucoma, diabetic retinopathy, retinitis pigmentosa, inoperable cataracts or other eye diseases, experience great difficulty reading and performing many of life's activities safely and effectively. These challenges can result in severe loss of independence. The good news is that we have a wide array of products and technology to enhance and assist in performing life's activities.

Our goal is to serve those who have difficulty with tasks of daily living due to low vision and/or visual processing disorders. We carry the largest selection of empowering products for the visually challenged client and the professionals who serve them.

Our knowledgeable staff is specially trained to provide you with the caring assistance you deserve. If you do not see a specific product in this catalog, please call us, chances are we can still assist. We are your one-stop shop for all your low vision needs. We look forward to serving you!

Sincerely,
John Palmer, President, Patriot Vision Industries

Contents

1	ABOUT THIS USER GUIDE.....	5
2	ABOUT THE PATRIOT TITAN II 24FHD.....	6
3	BEFORE SWITCHING ON FOR THE FIRST TIME.....	7
3.1	EQUIPMENT / ITEMS DELIVERED:.....	7
4	SETTING UP THE PATRIOT TITAN II 24FHD ON THE TABLE	8
5	SWITCHING ON FOR THE VERY FIRST TIME AFTER ASSEMBLY.....	9
6	THE CONTROL UNIT OF PATRIOT TITAN II 24FHD.....	11
7	BRIEF OVERVIEW OF THE CONTROLS.....	12
8	GET TO KNOW YOUR NEW PATRIOT TITAN II 24FHD.....	13
9	TROUBLESHOOTING	19
10	DEFECTS AND REPAIR.....	21
11	SERVICE	22
12	COMPLIANCES	23
12.1	CE CONFORMITY.....	23
12.2	FCC CONFORMITY	23
12.3	ENVIRONMENTALLY FRIENDLY DISPOSAL ACCORDING TO EU-DIRECTIVE 2012/19/EU24	
13	WARRANTY	26
14	FOR YOUR SAFETY	27
15	TECHNICAL DATA.....	30

Patriot Titan II 24 FHD

1 About this user guide

This manual is intended for all users of Patriot Titan II 24FHD. The device has already been set up by your dealer so that you have a fully functional device at your disposal. In this manual you will find all information required to use your Patriot Titan II 24FHD.

The manual is a part of your device. Please read this manual with care and attention as it contains important instructions and tips with regard to operating the device properly. Please keep the manual always within reach of your device and do pass it on to a next owner.

Copyright © 2021 VisioBraille GmbH, Ossmaritzer-Strasse 4c, D - 07745 Jena, Germany. All rights reserved. No part of this publication may be reproduced or distributed in any form or by any means, or stored in a database or retrieval system, without prior written permission from VisioBraille GmbH.

All efforts have been made to ensure that information contained in this document is correct at the time of issue. Neither VisioBraille GmbH nor its representatives assume any responsibility for errors or omissions. Nor is any liability assumed for damages resulting from the use of information contained herein.

Licenses and trade marks

All licenses and trade marks are the property of their respective owners.

2 About The Patriot Titan II 24FHD

Attractive design, simple operation, excellent image quality - that's what The Patriot Titan II 24FHD stands for.

The Patriot Titan II 24FHD has a high-resolution camera and a 24 "widescreen monitor in 16:9 for-mat with energy-saving and high-contrast LED lighting. The high resolution of the camera ensures a razor-sharp image even at the smallest magnification.

The Patriot Titan II 24FHD has a XY-table and a color camera, also has 6 control buttons and offers an extremely wide range of functions such as an adjustable reading line.

The Patriot Titan II 24FHD one of the smallest, lightweight and best designed devices. It is characterized by its extraordinary design. The Patriot Titan II 24FHD has all the properties you would expect from an excellent screen-reading device.

In addition to full color display and auto-focus, The Patriot Titan II 24FHD has numerous color mode display options. Reversal of foreground and background color is of course also available. There is also the option to switch off the auto focus, e.g. to fill out forms or to make handwritten notes. Thanks to the image optimization function, The Patriot Titan II 24FHD always offers optimal image quality.

The Patriot Titan II 24FHD is able to display even documents of very poor quality, such as pale print or crumpled, dirty paper, in a legible manner on the screen. Despite the high technical effort, it can happen that in rare cases an original cannot be displayed more legibly, e.g. with highly reflective reading material.

3 BEFORE SWITCHING ON FOR THE FIRST TIME

Please read the safety instructions at the end of this manual and check that the scope of delivery is correct.

3.1 Equipment / Items delivered:

- 1 Patriot Titan II 24FHD screen-reading device
- 1 AC-Adapter
- 1 power cable
- 1 User Manual

4 Setting up the Patriot Titan II 24FHD on the table

Place your Patriot Titan II 24FHD on your table in such a way that the front edge of the XY-table, which has been fully extended to the front, is just flush with the edge of the table. Even with maximum movement of the XY-table to the left or right, it must not protrude over one of the table edges. This ensures that the device is in a safe position.

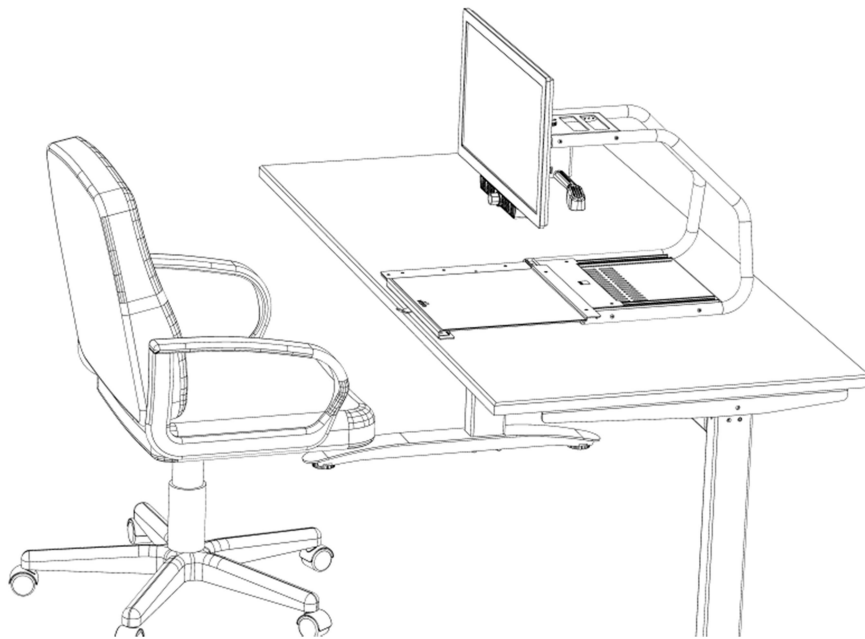

Picture 1

5 Switching on for the very first time after assembly

You can skip this chapter, as the following steps were usually carried out when the device was delivered and are only mentioned here for the sake of completeness.

Connect the power pack of your Patriot Titan II 24FHD to a live power socket and the plug on the other side of the power pack into the camera unit. The power supply input (see Figure 2) is on the right-hand side of the camera unit. The ready LED lights up immediately after plugging in and lights up continuously.

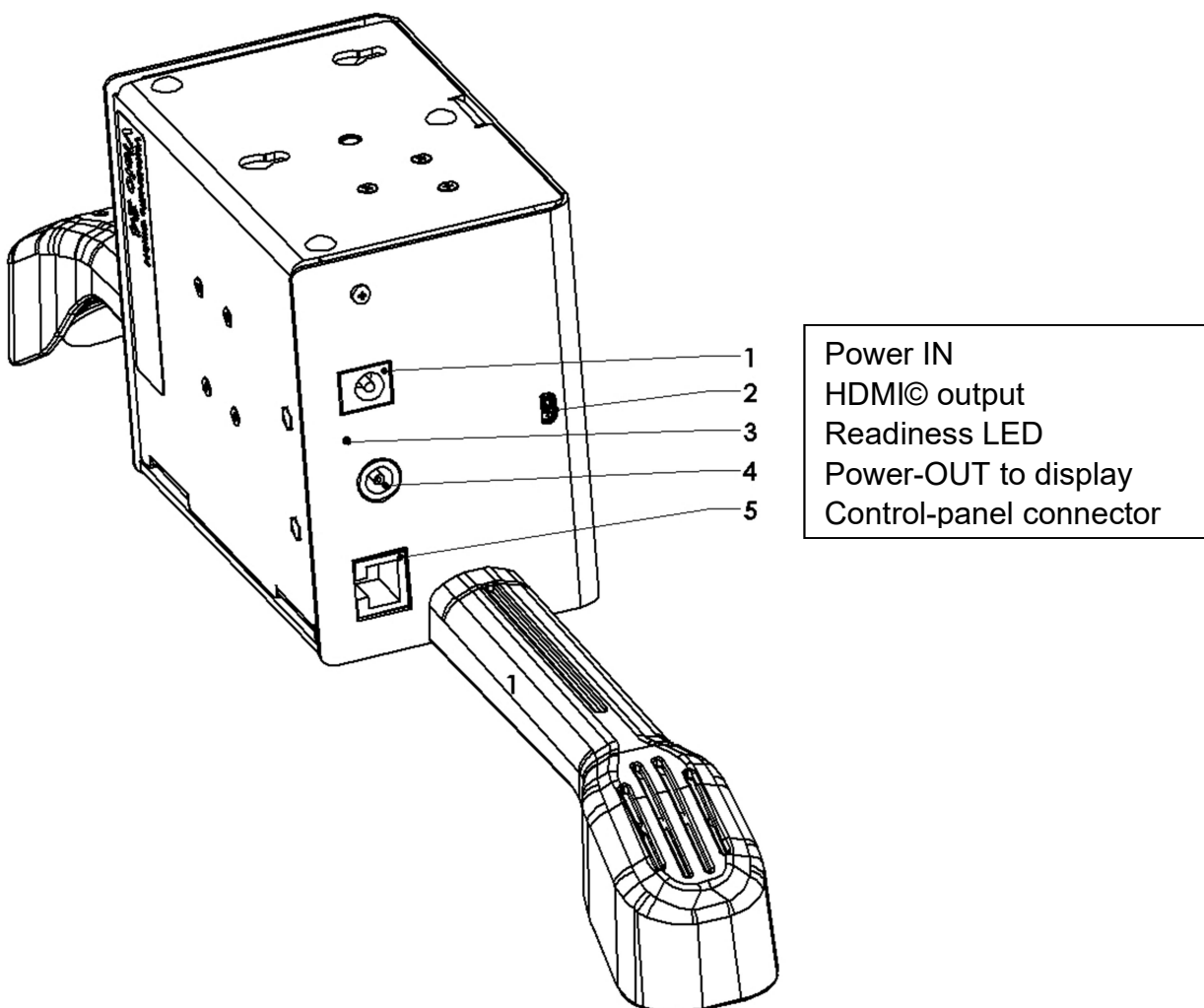

Picture 2

Press the power switch  on the far left of the control unit below the monitor for about a second. As soon as the lighting switches on, you can release the switch. The monitor also switches on immediately. (Note: The white control lamp on the right at the lower edge of the monitor lights up continuously.)

If necessary, the power-on-switch of the monitor is directly under the control lamp. You can place your finger on the lower right edge of the screen and move it to the left until you feel the slight bump of the power button. After pressing this button, the power-on control lamp lights up white. The Patriot Titan II 24FHD from now automatically switches on the monitor.

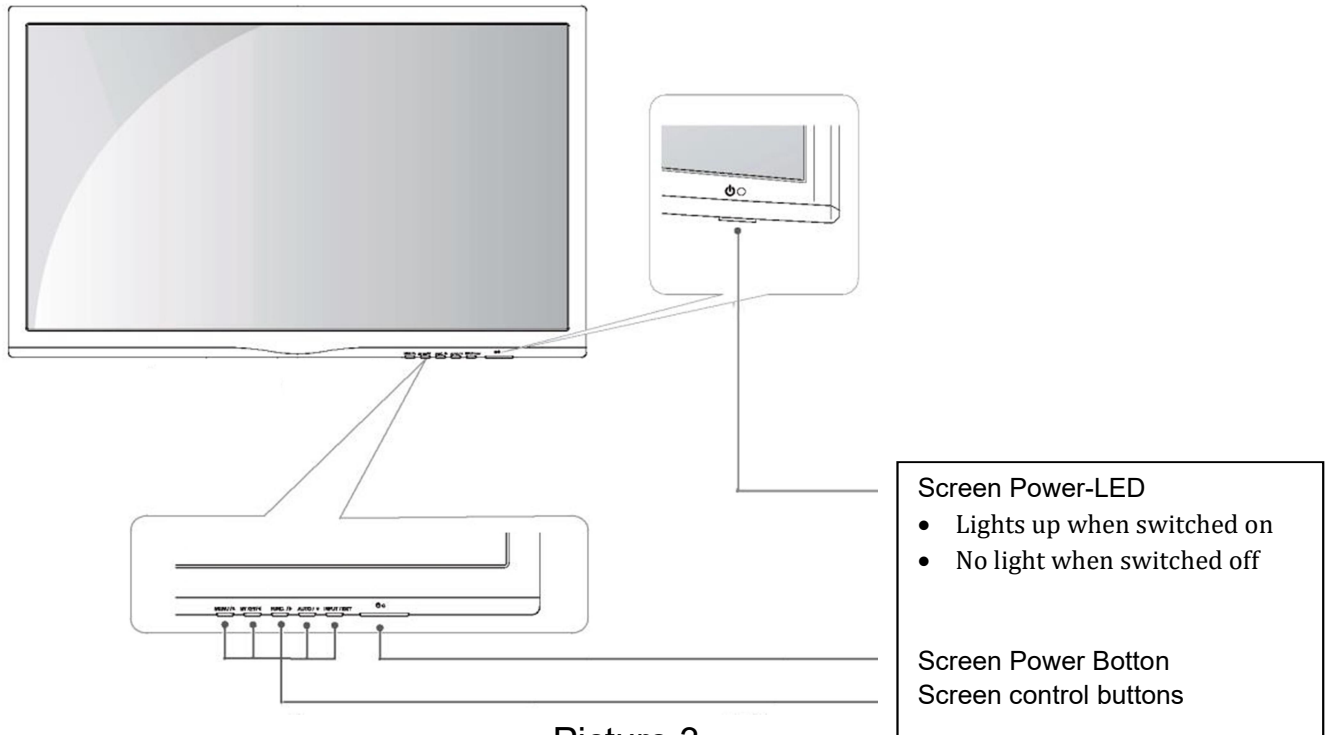

Picture 3





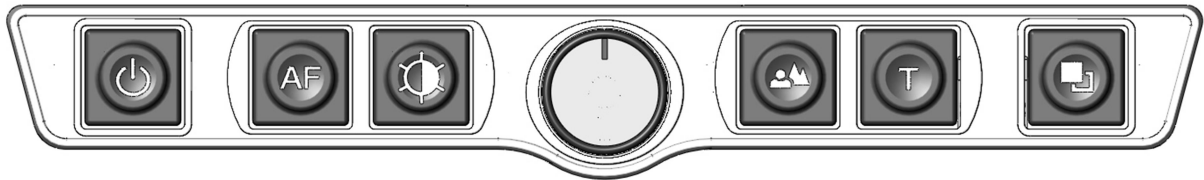

These steps only need to be done when switching on for the first time after delivery. Then it is sufficient to switch the Patriot Titan II 24FHD on and off on its control unit.

6 The control panel of the Patriot Titan II 24FHD



Picture 4

7 Brief overview of the controls

	<p>Power button Press for about 1 second (until lighting comes on) to switch on the device. Long press to turn off.</p>
	<p>Autofocus Switches between auto focus on and off. An autofocus always has a sharp image. Auto focus off when taking handwritten notes.</p>
	<p>Image optimization Switches between the 5 image optimization levels. Improves the image quality with difficult originals.</p>
	<p>Zoom / Enlargement & Reading Line / Reading Gap Turning to the left reduces the magnification, Turning to the right increases it.</p> <p>Pressing it briefly shows the reading line. Repeated short presses hide the reading line again.</p> <p>A long press shows the reading gap. Repeated long presses hide the reading gap again.</p>
	<p>Picture View pictures or documents in real color. Also recommended for reading documents with poor print quality.</p>
	<p>Text – inversion Use text mode to read. The contrast is greatly increased so that you can read more relaxed. Press the key again to reverse the foreground color and background color.</p>
	<p>False colors In text mode: Press this button to choose between the 12 false color displays. (The text key reverses the foreground and background) In picture mode: white balance - neutral white, warm red tone, cold bluewhite.</p>

8 Get to know your new Patriot Titan II 24FHD

You have already learned how to set up the Patriot Titan II 24FHD optimally on your table and how to supply The Patriot Titan II 24FHD with power.

You can tilt the screen slightly for more comfortable reading. Do not try to tilt the screen too far by going past the stop. The Patriot Titan II 24FHD has a height adjustment of the screen! Move the monitor up and down together with the control panel. You do not need any tools for this.

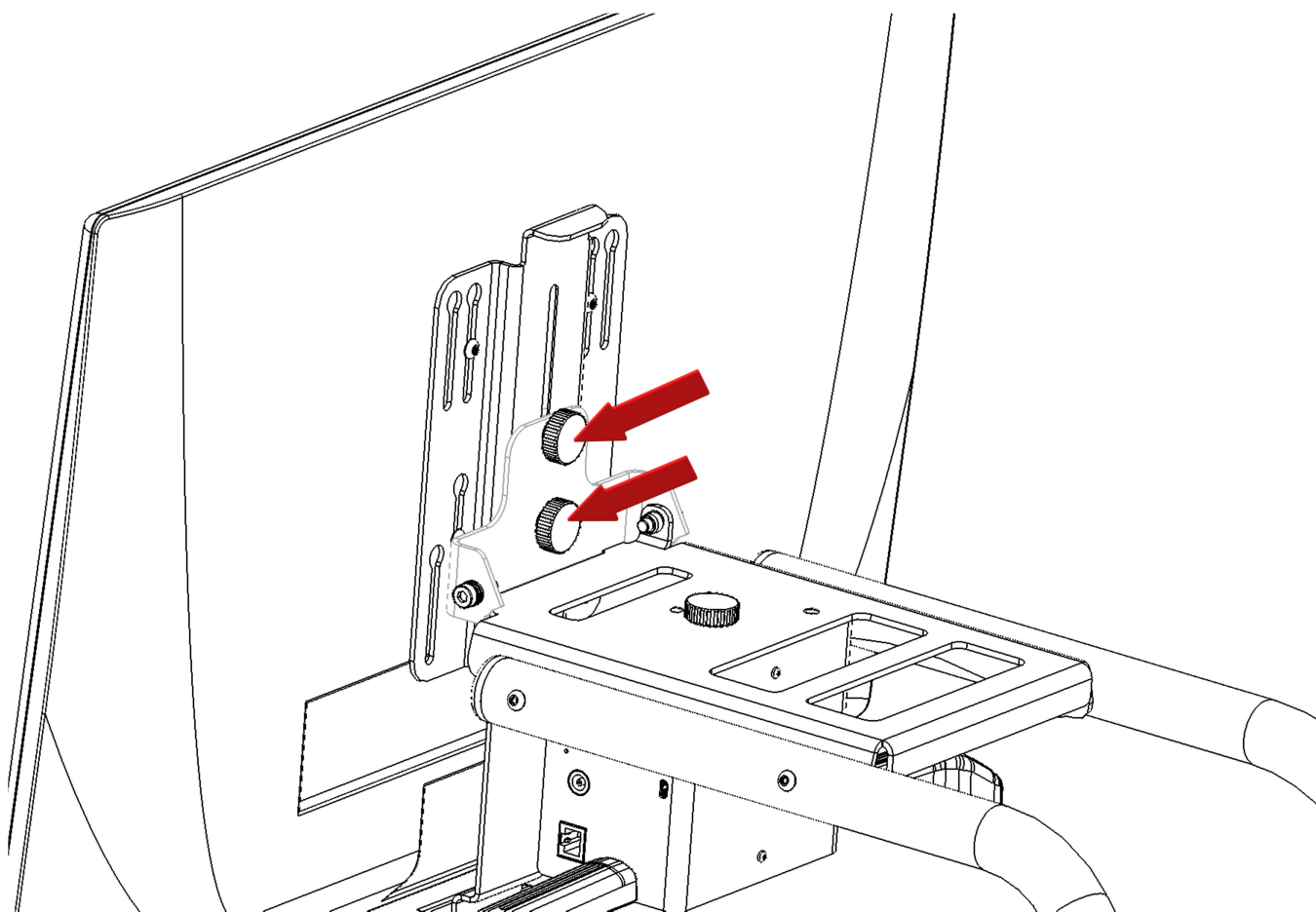

Picture 5

Proceed as follows:

[Important: always keep one hand at the bottom of the monitor]

Tilt the monitor back slightly.

Turn the two fixing screws (see arrows in Figure 5) on the back of the monitor half a turn to the left.

Grasp the top and bottom of the monitor and slide it to the desired height.

Tighten the two fixing screws again to the right.

Now switch on the Patriot Titan II 24FHD to use it.

The **control unit** is located directly in the middle under the screen. The on-switch is on the far left. Press the power button for about a second to turn on the device. As soon as the lights come on, you can let go of the switch. The monitor may display the message like "out of range ..." until you see the enlarged original on the screen after a few seconds.

To switch off the Patriot Titan II 24FHD, you have to press the on switch for longer than a second. This prevents you from switching off the Patriot Titan II 24FHD by accidentally briefly touching the switch. Practice turning it on and off a few times, then leave it on for the next few steps.

Place a template on the X/Y table. Take something colored, maybe a brochure or magazine with text and colored pictures.

To align the template exactly horizontally, push it back against the silver rear edge of the X/Y table. If you now slide the X/Y table from left to right, you will not slip in the line, as the template aligns itself on the edge parallel to the guide direction. This little trick will make your reading a lot easier.

The X/Y table has a brake for locking. You will find the brake lever on the front edge of the X/Y table. Move the lever all the way to the left to be able to move the X/Y table freely in all directions. With the lever in the middle position, you can move the X/Y table slightly to the right and left; the movement to the front and back is blocked. In the rightmost position, the table is firmly locked in all directions.

Now align your template with the rear edge of the X/Y table and move the brake lever all the way to the left.

 **Attention:** Avoid getting your fingers or clothing into the mechanics of the X/Y table below the reading plate to prevent them from being trapped. Keep your hands above the plate or on the front edge. Do not reach under the side or rear edges of the reading plate.

Now let's try the buttons on the control unit. You already know the on-switch on the far left of the control unit.

There is a round knob in the middle of the control unit. This is the zoom or magnification slider that you use to adjust the magnification. Turning clockwise increases the magnification, turning counterclockwise decreases it. Now turn the zoom control counterclockwise as far as it will go to minimum magnification.

The minimum magnification level is less for reading and more for providing an overview of the original. This makes it easier for you to find the area that you want to look at enlarged.

Now press the Image button. The **Image button** is located directly to the right of the zoom slider. Pressing the image button switches on the real color display, i.e. the Patriot Titan II 24FHD image mode. This setting is ideal for viewing photos, but it is also useful for reading documents that are of poor print quality. You see all colors and gray values in a natural representation.

Now move the X/Y table so that you can see one of the images of the template. If the image is too small, you can increase the magnification by rotating the zoom lever clockwise. If you got “lost” on the template because you accidentally moved the template, turn the zoom control counterclockwise to a smaller magnification, look for the correct position in this overview and then enlarge the image again.

Note: The Patriot Titan II 24FHD always starts with the minimum zoom level. So you always have an overview of the entire template when you switch it off and on again. The set magnification is approached immediately when you turn the zoom control a little to the left or right.

Now that you have learned a lot about your new Patriot Titan II 24FHD, let's read a text.

Move the XY table to a point on the template where you can find related text. Now press the text button. The Text button is to the right of the Image button, i.e. the second button to the right of the zoom controller. The original is now displayed with increased contrast and only two false colors. Press the Text button again to swap the foreground color and background color. Press the Text button a few times to familiarize yourself with the changes to the display and also toggle between image display and text display. Do you know the difference? In text mode, the font appears much clearer and richer in contrast, in picture mode you can see all the colors and gray values.

Don't like the two colors in text mode? No problem!

You have the choice between 12 different false color combinations. With the inversion, i.e. reversing the foreground and background color, you have a choice of 24 different representations. Select a different color combination by pressing the **false color key**. This is the rightmost button on the control unit. Each time you press this button, the color combination changes. When you have done all 12 combinations, it starts again with the first one. To swap the foreground and background color, press the text key.

The following color combinations are available:

Black-White, Black-Yellow, Black-Green, Black-Magenta, Black-Cyan, Blue-Yellow, Blue-White, Black-Ivory, Black-Soft_Yellow, Black-Soft_Peach, Black-Soft_Pink, Blue-Ivory

Select your preferred color combination with the false color key and, if necessary, press the text key to swap the foreground and background color. Take the time to find the setting that works best for you.

In picture mode, the false color key has a different function. Here you can change the white balance. Press this button to toggle between a neutral white (default setting), a warm shade of red, which is good for viewing photos with skin tones, or a cool blue and white, which is especially suitable for reading colored text.

Note: The Patriot Titan II 24FHD remembers the setting of the false colors. So if you switch from text mode to picture mode and then return to text mode, you will find the previously set color combination and inversion there.

Now that you have found your preferred color setting for reading in text mode, we now want to turn to the more problematic templates. In most cases, the Patriot Titan II 24FHD will display your enlarged original with good contrast, thanks to its automatic exposure. This is also easy with clean, black printing on pure white paper. Sometimes it happens, however, that the template is not ideal and the automatic system does not find the best setting. This can happen, for example, with colored writing or a colored background, or with poor photocopies with pale letters on gray paper. In these cases we use the **image optimization** button. It's the third button from the left, just to the left of the zoom controller. With this button you can regulate the automatic capture range in five stages.

So if you ever get a poorly legible picture from The Patriot Titan II 24FHD, simply press this button until the picture is best represented. This button is effective in picture mode and text mode.

Note: Often you just know that the last setting was the best when you are already one too far and the picture gets worse again. Since there are five different settings that run up and down, you only need to press the button seven times in succession to return to the previous setting.

Another help to find your way around a text is the **reading line**.

To activate the reading line, first set the desired magnification on the magnification control. Now press the center of the magnification control and release it shortly afterwards. You will notice that a black horizontal line is now displayed over the picture on the screen. You can now adjust this reading line with the magnification control clockwise upwards and counterclockwise downwards, the magnification does not change. You can hide the reading line again by briefly pressing the magnification control repeatedly. Reading gap feature is used to hide the image area above and below a line to be read and is activated by pressing and holding the zoom control. When you are in picture mode and have set the desired magnification, press the magnification control for about a second and release it again. You will now see a reading line that you can move up and down using the magnification control. The rest of the picture is black. You can hide the reading gap by pressing and holding the zoom control again.

Note: The reading line and reading line can also be displayed in all false color modes. In addition, you can change the color of the hidden area in the respective mode by pressing the false color key. You can choose between black and white.

Now we will explain the function of the auto-focus button. It may sound complicated, but it is very easy!

After switching on, the auto-focus, i.e. automatic focusing, is always switched on. This means, no matter how thick the book you want to read, or how curved its surface, the Patriot Titan II 24FHD always shows the enlarged section in focus. This is why you will usually work with this setting.

Sometimes, however, you want to fill out a form or a crossword puzzle, you may also want to paint your fingernails or take a closer look at a 3-dimensional object. This is where the fixed focus comes into play.

The auto-focus button is the second from the left on the control unit. If you press this, you switch the auto-focus between on and off. Now let's try how it works. If you've messed around with this button, press the auto-focus button once and turn the zoom control a little to the right. The Patriot Titan II 24FHD enlarges the original and focuses it automatically. If this is not the case, press the auto-focus button repeatedly and the Patriot Titan II 24FHD will focus the original. Now place your hand on the template. The Patriot Titan II 24FHD now enlarges your hand and you can see that your skin is now in focus and the letters at the edge are blurred. The same thing can happen when you want to fill out a form. Instead of making the letters sharp, it is possible that your hand, which is holding the pen, is sharp and the letters are blurred. If you take your hand away, the letters become sharp again.

Now let's try the same thing with the auto-focus off. To do this, place a form on the X/Y table. You can see that the letters are sharp, press the auto-focus button again to switch it off. If you now fill in the form with a pen, Patriot Titan II 24FHD will still keep the letters in focus and will no longer focus your hand. When you're done, don't forget to turn the auto-focus back on with the auto-focus button.

An additional feature of your Patriot Titan II 24FHD is to switch itself off after 5 hours without use. Should you accidentally not switch off your Patriot Titan II 24FHD, it will switch off after this time.

You did it! You are now familiar with all the setting options and functions of the Patriot Titan II 24FHD. We hope you enjoy your new Patriot Titan II 24FHD CCTV device.

9 Troubleshooting

So now it happened. The Patriot Titan II 24FHD does not work as expected and you are clueless if it is broken. Very often, a small reason can cause a big problem, which can be resolved easily. So please read the following checklist and try to find out what is wrong. If this does not help, please switch The Patriot Titan II 24FHD off, unplug the power cable from mains and contact our service department.

Display and lights remain dark

Please try to switch the Patriot Titan II 24FHD on again. If this does not help, make sure power supply is connected to both the Patriot Titan II 24FHD and wall outlet and that wall outlet is live. You may want to connect another device to the wall outlet to check.

Are all plugs seated properly in their sockets?

Only display remains dark, lights are on

Is the light in the display's lower right edge on? Is it red?

If not, switch the Patriot Titan II 24FHD off and on again or press the sensor button in lower right edge of display. Best you touch the edge and move your finger leftwards. Now the light should be on and red.

If not, please check if power cable in back of display is seated properly. At the Patriot Titan II 24FHD, the short power supply cable for the display comes out of the camera housing behind the display.

Image is blurred

Check if protective plastic foil is still covering camera lens (remove this foil) or whether this lens is dirty. If so, clean with a dry, soft cloth.

Turn zoom knob clockwise in middle position.

Document cannot be read - Turn zoom knob clockwise.

Try different setting of Image optimizer button.

X/Y Table is not moving

Move lever to leftmost position.

Letters are fluttering

Increase zoom by turning zoom knob clockwise.

Try different settings of Image optimizer button.

NOTES

10 Defects and Repair

If The Patriot Titan II 24FHD is broken – what to do?

- Did you check all settings and connections according to the manual?
- Did you remove the protective plastic film from the camera lens?
- Are you sure the mains outlet is live?

Do not use a broken device! Unplug broken device from power supply! Please do not hesitate to contact your local distributor Patriot Vision Industries, LLC.

You can reach Patriot Vision Industries, LLC. 1-800-364-1608. We will help you check your Patriot Titan II 24FHD and if the unit is broken, we will assist with getting the unit back to us for repair. Show this manual to the person who will help you package the Patriot Titan II 24FHD in the shipping box.

Contact:

Patriot Vision Industries, LLC.

2125 SW Highway 484

Ocala FL 34473

Phone: 1-800-364-1608

Web: www.patriotvisionindustries.com

Email: info@patriotvisionindustries.com

11 Service

For shipping The Patriot Titan II 24FHD, proceed as follows:

- Switch off the Patriot Titan II 24FHD
- Unplug from power supply
- Put display in upright position, fasten brake of X/Y table
- We recommend keeping the box your unit was received in and padding that the unit came wrapped with.
- The ideal shipping box is 24 x 24 x 24 along with thick padding is recommended.
- Cover left and right side of display with padding.
- Hold the Patriot Titan II 24FHD by the handle on upper side and put it in the shipping box.
- Insert padding on top of monitor and put power supply in smaller pocket.
- Close box.

12 Compliances

12.1 CE Conformity

This product conforms to the guidelines of the European Union and takes the CE- and ROHS Marking



12.2 FCC Conformity

1. This device complies with Part 15 of the FCC Rules. Operation is subject to the following two conditions:
 - (1) This device may not cause harmful interference
 - (2) This device must accept any interference received, including interference's that may cause undesirable operation
2. Changes or modifications not expressly approved by the party responsible for compliance could void the user's authority to operate the equipment.



NOTE: This equipment has been tested and found to comply with the limits for a Class A digital device, pursuant to Part 15 of the FCC Roles. These limits are designed to provide reasonable protection against harmful interference in a residential installation.

12.3 Environmentally friendly disposal according to EU-Directive 2012/19/EU



The symbol (crossed garbage can), which is also attached to the device, states that this device and its accessories, once come to the end of its lifetime, should not be regarded as household waste. An environmentally friendly way of final disposal is compulsory.

This device contains electronic components. In order to avoid risks or dangers for the environment through non-professional waste disposal, the disposal of this device and its accessories must correspond to the valid EC-Directives or other local regulations. Please check your local regulations for proper disposing of this device or consult your local distributor.

For data privacy protection reasons, please remove all personal data from the device prior to disposal.

EU Konformitätserklärung
EU Declaration of Conformity

Wir, die Firma
We, the company

VisioBraille GmbH
Ossmaritzer Str. 4c
07745 Jena
Germany

erklären in alleiniger Verantwortung, dass das weiter unten genannte Produkt
declare under our sole responsibility that the following product

Geräteart/ <i>Type of product:</i>		Elektrische Lesehilfe / <i>reading aid</i>
Handelsmarke/ <i>Trademark:</i>		VisioBraille
Modell <i>Model</i>	Artikelnummer <i>Article-no</i>	weitere Angaben <i>further details</i>
Visio24	-	keine Batterie / <i>not battery operated</i>

die grundlegenden Anforderungen der aufgeführten EU-Richtlinien erfüllt:

2014/30/EU	Richtlinie über die elektromagnetische Verträglichkeit
2011/65/EU	Richtlinie zur Beschränkung bestimmter gefährlicher Stoffe in Elektro- und Elektronikgeräten

meets the essential requirements of the following EU-Directives:

2014/30/EU	<i>Directive on Electromagnetic Compatibility</i>
2011/65/EU	<i>Directive on the restriction of the use of certain hazardous substances in electrical and electronic equipment</i>

angewandte Standards und Verordnungen/*applied standards and regulations:*

EN 55024:2010
EN 55032:2015
EN 55035:2017
EN 50581:2012

Bevollmächtigter zur Zusammenstellung der technischen Unterlagen:
Authorized person for technical documentation:

Name/*Name*, Position: Thomas Lucas, CEO

Jena, 07.07.2021
Datum/*Date*

Unterschrift/*Signature*

13 Warranty

Patriot Vision Industries, LLC. warrants the device, effective from the date of delivery, to be free of any defects in material and workmanship. Warranty is not transferable and does not apply to groups, multi users or agencies. This device has been de-signed for the individual purchaser to be used in home or office environments. Patriot Vision Industries, LLC. reserves the right to repair or replace with a similar or better product. In no event shall Patriot Vision Industries, LLC. or its distributors be liable for indirect or consequential damages. The original users' remedies are limited to replacement of devices modules/parts. This warranty is valid only when service is done in the country of original purchase and with intact warranty seals. For additional warranty claims or service during or after warranty period, please refer to your local distributor. Patriot Vision Industries, LLC. does not take responsibility for use of this device other than described in this Manual.

- Warranty on new devices is 24 months.

All defects caused by improper use or users fault are not covered by this warranty.

Warranty will be void if warranty seal is damaged.

Parts replaced during repair are transferred into ownership of Patriot Vision Industries and will not be returned to the customer.

In case of repair the device must be properly packed into its original shipping box.

Costs for packing, shipping and insurance are NOT covered by Patriot Vision Industries.

14 For your safety

 **Important note:** Failure to observe the following warnings may invalidate the guarantee and could cause damage of the device or serious injury.

Please check contents of package before you use the device. If parts are damaged or missing, please do not hesitate to inform your dealer.

Please keep the shipping box, so you can safely pack the device in case you have to ship it for service, etc. Improper packaging could cause loss of warranty. In case you need a new shipping box, your dealer can send you one.

Please carefully read the user guide and safety instructions before you use the device for the first time.

This device may only be used in a home or office environment.

Do not place on an instable surface. It may fall causing serious damage to the device or injury to the user. Please follow the instruction on how to place the device especially in respect to avoidance of tilting and falling down by keeping proper space to edges of table.

The Patriot Titan II 24FHD contains moving parts. Please take care when adjusting the display or moving the arms to fold the device. Injury may occur if fingers or clothing are caught in the operating mechanism. If you have difficulties in operating the unit safely, please seek advice or contact your local dealer.

Connect the power supply to a grounding-type power outlet only.

Do not use the device if you find any damages at device or wires.

If the device appears to be operating abnormally, or to be damaged in any way, please contact Patriot Vision Industries at 800-364-1608 as soon as possible.

If you smell smoke or an odor coming out of the device, turn off the power immediately.

Do not try to repair the device yourself. Opening or removal of housing may cause damage or injury.

Do not allow sand or dust to come into contact with the device as this may lead to serious damage and could make repair impossible.

Use the device with clean hands only.

Do not use in locations where strong radio waves are emitted or where there is radiation. Keep a distance of at least 30cm to mobile phones.

Only use original accessories. Use of second source accessories may damage the device or cause malfunction or safety issues.

Do not use a power supply not made for this device. Only use the original power supply!

Do not use the power supply with other devices.

Avoid liquids and food near the device.

Do not use or store the device in any of the following places as this may cause damage:

- Inside cars parked with the windows closed in the hot sun.
- In direct sunlight or close to heaters, radiators, etc.
- Locations subject to severe vibration such as on top of a washing machine.
- Locations subject to strong magnetism such as near loudspeakers.
- Humid places (bath room), in water, or near water.
- In rain or snow
- Do not use or store below 0°C or above 40°C.
- Humidity shall be within 20% to 80%
- Avoid fast temperature changes

If you bring the device from cold places into a warm room, humidity may condensate. Wait until the device is dry and well-tempered to room temperature before use.

Unplug from power before cleaning.

Wipe dust and dirt from the device with a soft cloth dampened with a diluted neutral detergent, then wipe dry with a cloth. Do not bring in contact with water.

Do not insert objects into openings.

Do not use device during thunderstorms. Unplug from mains during thunderstorms. We recommend use of an overvoltage protection adapter, which can be bought from your local electro store. Please note, this does not provide a 100% protection from overvoltage.

Do not insert or remove the plug with wet hands.

Do not heat in a microwave oven, on a cooker or similar.

Never disassemble, attempt to repair or modify device yourself.

If liquids or metal fragments should enter device, switch it off and remove the power lead immediately.

Do not pull the plug out by the lead when removing the power plug.

Avoid shock. Do not throw or let fall.

Repairs may only be carried out by Patriot Vision Industries, LLC. or by VisioBraille GmbH authorized companies.

Care and maintenance

Avoid damp and water.

Use only a clean, dry cloth to clean the housing of the device. Do not use any cleaning fluids or solvents. Wipe dust and dirt from the housing of the device with a soft cloth (stay clear from the Camera unit and Roll-bars!) Contact your dealer for intensive and professional cleaning of your device.

Protect the device from extreme heat, e.g. from the sun, heating units, hot cars etc.

With extreme cold and frost the device becomes inoperable and must be brought slowly back to room temperature. Under no circumstances must the device be warmed up or “thawed out” in a conventional oven, microwave oven or any other heating device!

Avoid any mechanical damage to the housing or accessories.

15 Technical Data

- CCTV magnifying device with High-Resolution camera and widescreen display (up to 400% more Pixels as traditional CCTV's)
- Refresh rate 60 Hz
- Display diagonal 60,45 cm (24 in.) in 16:9 format
- Monitor with LED Backlight
- Maintenance-free LED reading lights
- 32 bit Full colour
- 12 False colours with enhanced contrast + Reverse image giving 24 combinations (Black-White, Black-Yellow, Black-Green, Black-Magenta, Black-Cyan, Blue-Yellow, Blue-White, Black-Ivory, Black-Soft_Yellow, Black-Soft_Peach, Black-Soft_Pink, Blue-Ivory)
- Auto Focus
- Fixed focus for writing
- Automatic exposure
- Reading line and reading gap
- Zoom range approx. 2,8 to 60 times
- Lightweight design (approx. 11,5 kg (= approx. 25.4 lbs.))
- Dimensions: approx. 530 mm x 630 mm x 580 mm (= approx. 20.9 x 25 x 22.8 in.)
- Power supply: 100-240 V AC 50/60 Hz 1.7 A max.
- Power consumption: Operation / Standby: approx. 28 W / < 0,1 W
- Protection Class 1
- Indoor use only



 **Manufacturer:**

VisioBraille GmbH
Ossmaritzer-Strasse 4c D -
07745 Jena Germany

Distributed by:

Patriot Vision Industries, LLC
2125 SW Highway 484
Ocala FL 34473

Phone: 1-800-364-1608

Fax: 1-352-203-4617

Email: info@patriotvision.com

Web: www.patriotvision.com

Patriot Vision Industries, LLC, is an affiliate of Low VisionAids, Inc. Patriot, Magnifying America, the words and their symbols/logo/mark are licensed trademarks owned by Low VisionAids, Inc.

Copyright 2025. All Right Reserved. Designed & Assembled in USA.
Please be advised that this user guide may contain errors, and is therefore subject to being changed or updated without prior notice.