

Patriot 5 EZ User Manual

Contents

Welcome	3
Product Features.....	3
Packaging & Accessories.....	5
Technical Specifications.....	5
Product Illustration.....	6
How to Use	7
1. Install handle	7
2. Install battery	8
3. Battery charging.....	9
4. Power on/off.....	9
5. Using Patriot 5 EZ.....	10
Functions Introduction	11
1. Color mode switch.....	11
2. Zoom rate adjustment.....	11
3. Image freeze and unfreeze.....	13
4. Memory Function for Settings.....	13
5. Power saving.....	14

6. Low battery tips.....	14-15
7. Handwriting.....	15
8. HDMI connecting to TV.....	16
System Menu Guide	16
●LCD brightness adjustment.....	17
●White LED brightness adjustment.....	18
●Beep volume adjustment.....	18
●Date and time setting.....	19
●Color mode setting.....	19
●Battery power display.....	20
●Version information display.....	20
Precautions	21
Troubleshooting	22
Contact Us	23

Welcome

Congratulations on your purchase of the Patriot 5 EZ Digital Magnifier. A powerful electronic magnifier that is easy to use so that you can maintain a high-quality life and greater independence.

Please read this manual carefully and keep it for reference.

Product Features

This Full HD 5.0 Patriot 5 EZ portable digital video magnifier is the most powerful and easy to use digital magnifier at an affordable price.

- 5 inch large anti-glare screen, 800*480 resolution, high definition screen.
- Auto focus design, full depth of field coverage from 5cm to 15cm.
- Custom-made quality lens, large field of view and extended depth of field.
- No lag & fluent HD.
- Professional image processing DSP to restore colors and enhanced image.
- 2X-32X variable amplification.
- Two-color button, high contrast, tactile touch.

-
- Fold out stand for angle viewing and rotatable handle.
 - Handle can be relocated for left handed users.
 - Multiple color modes.
 - Color mode customization capable.
 - Picture freeze feature.
 - Large icon user interface.
 - Backlight adjustable, White LED light brightness adjustable, suitable for reading all materials.
 - Memory function will automatically save the last settings.
 - HDMI 1080i60 output to HD TV.
 - TYPE-C USB interface.
 - High capacity re-chargeable battery, 4 hours runtime.
 - Intelligent power-saving design. Automatic shut-down after the screen dormant for 3 minutes.

Packaging & Accessories

●Digital video magnifier	1PC	●User Manual	1PC
●HDMI cable	1PC	●Protective bag	1PC
●USB charging cable	1PC	●Cleaning cloth	1PC
●Power adapter	1PC		

Technical Specifications

- Screen size: 5.0 HD colorful LCD screen(800*480);
- Pixel size: 8 mega pixels;
- Zoom rate: 2X to 32X variable;
- Color mode: 26 combinations available;
- Auto focus: 5cm ~ 15cm;
- White LED adjustment;
- Brightness adjustment;
- Memory function;
- Image freeze;
- TV output: HDMI 1080i60;
- Handle bracket: foldable and rotatable;
- Handle detachable: can be used for left and right hand users;

- Working hours: last for over 4 hours;
- Battery capacity: 2500mAH high-capacity re-chargeable lithium battery, user removable;
- Device dimension: 145mm(length)x 84mm(width)x 28mm(height);
- Device weight: 225g(Battery excluded);

Product Illustration

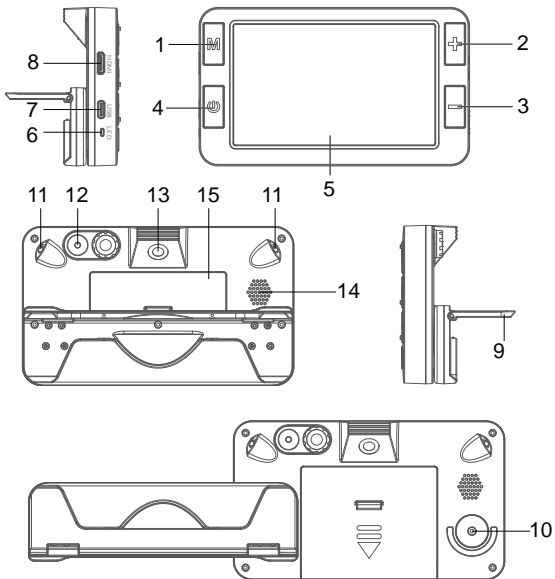

- | | |
|------------------------------------|--------------------------|
| 1. Mode button M | 9. Handle bracket |
| 2. Zoom in button + | 10. Left handed mount |
| 3. Zoom out button - | 11. Near focus White LED |
| 4. Power on button ⏻ | 12. Flashlight light |
| 5. LCD | 13. Near focus lens |
| 6. Indicator light(power/charging) | 14. Speaker |
| 7. TYPE-C USB interface | 15. Battery cover |
| 8. HDMI-C interface | |

How to Use

1. Relocate handle Option (LEFT HANDED USERS ONLY)

Handle may be mounted on the opposite side for left handed use.

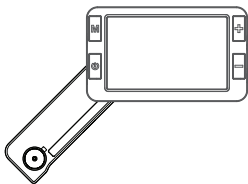

Left hand use

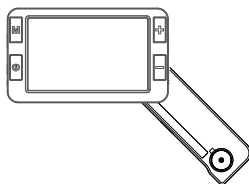

Right hand use

1. Loosen the handle screw and remove the handle
2. Take out the rotating shaft and the rotating shaft cover, and exchange the two positions;
3. Open the handle, remove the handle limit pin and install it on the other side;
4. Close the handle and tighten the screw;
5. Insert the handle to the rotating shaft and tighten the screws;

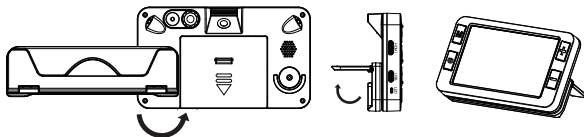

2.Install battery

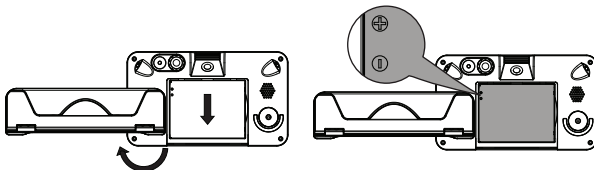

Rotate handle out of way

Install battery

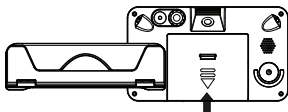

Close the battery cover

- 1.Invert Patriot 5 EZ, rotate handle out of the way from battery compartment;
- 2.Press the battery cover compartment and slide the battery cover off. (down);
- 3.Install the battery according to the positive and negative tips;
- 4.Cover the battery compartment, push up and slide into place. You will hearing the "click" sound;

3. Battery charging

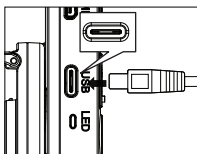

Connecting to
video magnifier

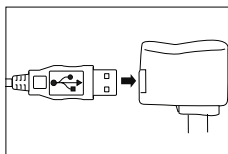

Connecting to adapter

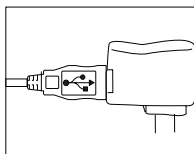

Connecting to
AC power

1. Connecting Patriot 5 EZ to adapter by USB cable;
2. Connecting adapter to AC power;
3. Charging light(red light) is on when charging;
4. Charging light(red light) will be off when completely charged;
5. Please charge the battery to 100% before using the Patriot 5 EZ for the first time;
6. When low battery signals, please charge the battery;

Attention: When charging, please make sure the charger and the Patriot 5 EZ are in a well vented area.

4. Power on / off

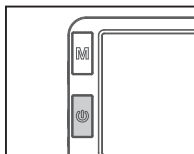

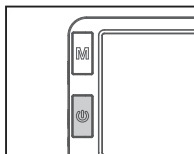

To power on, Long press
bottom left power button to
switch on



To power off, Long press
bottom left power button
to switch off

Using Patriot 5 EZ

1. Long press bottom left power on button  , Patriot 5 EZ will turn on, the green indicator lights up, ready to use;
2. Aim Patriot 5 EZ toward the reading material to magnify;
3. Optimal reading can be attained through adjusting magnifying power and colors;
4. Long press power on button  and Patriot 5 EZ will power off.

Attention: For best results, remove the protective film from the screen and/or the lens, if covered, before use.

5.Four Buttons explained:

Color mode switch: Press Mode button **M** to switch color mode;

Zoom in and out: Press Zoom in button **+** to enlarge image and press Zoom out button **-** to shrink image;

Freeze and unfreeze image: Short press Power button  to freeze image and short press Power button  again to unfreeze image;

System menu setting: Long press mode button **M** to enter setting menu to change or customize user settings.(see next page)

Functions Introduction

1. Color mode switch

You may cycle different color modes by pressing the Mode button **M**
There are 26 different mode;

- | | | |
|--------------------------|--------------------|--------------------|
| 1)Color mode | 10)Black on yellow | 19)Orange on black |
| 2)Color enhancement mode | 11)Yellow on blue | 20)Black on orange |
| 3)Negative mode | 12)Blue on yellow | 21)Yellow on green |
| 4)Monochrome mode | 13)Green on white | 22)Green on yellow |
| 5)Black on white | 14)White on green | 23)Red on white |
| 6)White on black | 15)Orange on white | 24)White on red |
| 7)Blue on white | 16)White on orange | 25)Yellow on white |
| 8)White on blue | 17)Red on black | 26)White on yellow |
| 9)Yellow on black | 18)Black on red | |

The desired color mode(s) can be customized. See page 19;

2.Zoom rate adjustment

2X Magnification
Illustrated

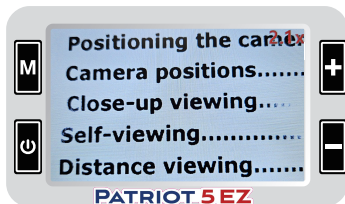

16X Magnification
Illustrated



32X Magnification
Illustrated



Zoom in **+** or zoom out **-** can adjust zoom rate to achieve the best magnifying effect;
Patriot 5 EZ can zoom in or zoom out variably between 2X ~ 32X.

3. Image freeze and unfreeze

Freeze image
viewing

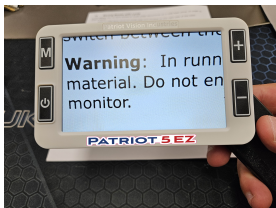

Viewing image
after freezing



Short press Power button  can freeze image and can observe the image at close distance,

Short press Power button  again to unfreeze image and return to real-time view.

4. Memory function for settings.

After turning off, Patriot 5 EZ will remember your setting.

5. Power saving

Patriot 5 EZ has a power saving function. When left idle, for more than one minute, it will enter sleep mode.

You will see this screen

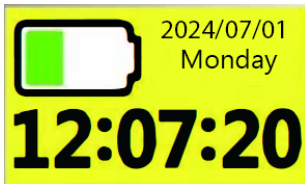

Under sleep mode, press any key to wake up Patriot 5 EZ. If left idle for three minutes, it will shut down automatically to save power.

6. Low battery tips

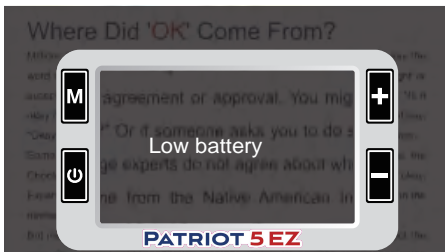

Low battery function: Screen will display the low power icon on low battery, and the power light flashes.

When low battery occurs, please charge the battery.

7. Handwriting

Patriot 5 EZ supports handwriting. Rotate handle, open the bracket support to incline the stand, and keep the magnifier upright to write;

Reading on incline
stand bracket

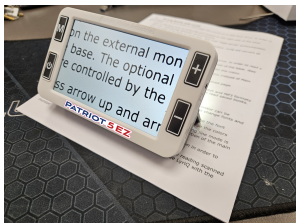

Writing on incline
stand bracket

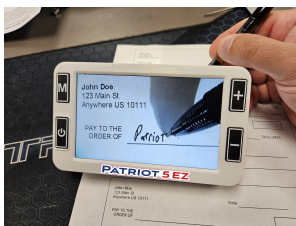

The incline stand bracket makes Patriot 5 EZ into a stand magnifier that can be slid across the page.

You may want to rotate Patriot 5 EZ 180 degrees for left handed writing.

8.HDMI connecting to TV

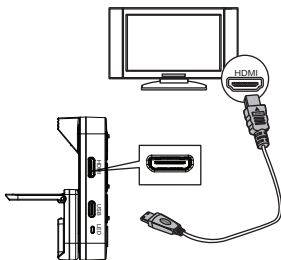

HDMI connecting to TV

If you want to connect Patriot 5 EZ to the TV by HDMI cable, please use the provided cable.

When Patriot 5 EZ enters the HDMI output mode, the Patriot 5 EZ screen will turn off automatically.

System Menu Guide

When the **M**(mode) button is pressed on the Patriot 5 EZ, it will show the MENU screen.

Operation/Pressing button		POWER button 	M button M	Zoom-in button +	Zoom-out button -
VIEW	Short press	Freeze/Unfreeze	Color mode switch	Single time zoom-in	Single time zoom-out
	Long press	Power on/off	Enter into Menu	Continuous zoom-in	Continuous zoom-out
MENU	Short press	Confirm	Next Menu	Previous option	Next option
	Long press	Power on/off	Exit Menu	/	/

Note: Access to MENU screen to change options is by long pressing **M** (mode) button. zoom in button **+** and zoom out button **-** can adjust between 1 ~ 5 levels.

● LCD brightness adjustment



Brightness 1



Brightness 3



Brightness 5

● LED Light brightness adjustment

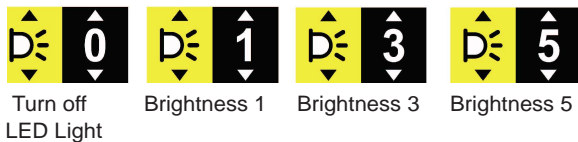

As shown above, zoom in button **+** and zoom out button **-** can adjust between 1 ~ 5 levels.

Attention: Level 0 will disable the LED light. This is mainly for reading mobile phones or laminated glossy surfaces to eliminate the glare.

● Beep volume adjustment

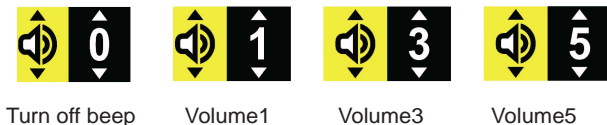

As shown above, zoom in button **+** and zoom out button **-** can adjust between 1 ~ 5 levels.

●Date and time setting

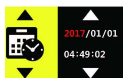

Year setting



Month setting



Date setting



Hour setting

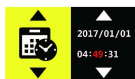

Minute setting



Second setting

As shown above, zoom in button **+** and zoom out button **-** can adjust value. Short press **⏻** button to move setting option.

●Color mode setting



Color mode



Open black on
white mode



Turn off black on
white mode

As shown above, zoom in button **+** and zoom out button **-** can switch. Short press **⏻** button to turn on or turn off mode; Only the selected mode will be used in the mode switch; the unselected mode will be skipped in the mode switch.

Attention : Color mode cannot be turned off.

●Battery power display



Low power,
to be off.



Low power



Half power



Full power

As shown above, battery power will be displayed as a percentage.

●Version information display



Version information

As shown above, the version information menu displays the product model, firmware version number, and firmware compilation time.

Precautions

In order to keep your Patriot 5 EZ in the best condition, please read the following notes carefully:

- Please do not expose it directly to high temperatures or sunlight;
- Please keep it away from moisture, rain, liquids and chemicals;
- Please do not use it near to electronic equipments, and medical equipments, which are not under insufficient shield;
- Please ensure that using it at temperatures between 10 ° C and 40 ° C;
- Please ensure that it is stored at temperatures between -20 °C and 65 ° C;
- Do not try to repair or open the unit to avoid voiding warranty;
- Please use the provided power supply and battery, otherwise unit will be subject to failing/malfunctioning;
- Use soft cloth to clean it, alcohol solvents or any other cleaners cannot be used.

Warning:

Do not use Patriot 5 EZ while charging!

Troubleshooting

Problem	Solutions
Black screen	Long press power button to power on; Battery without power, charge battery; Make sure the unit focuses on the reading materials;
Can not power on	Battery without power, charge it;
No sound	Make sure if the volume is at 1 to 5 in the menu setting;
Patriot 5 EZ focus is blurred	Make sure the environment is not dark;
Image is too dark or too bright	Make sure the lens is properly focus on the reading;
Image is blurred	Wipe the screen and lens;
Reading text is too small	Adjust zoom rate by pressing the zoom in button;
Connected to the TV, but the TV is not shown	Make sure the TV is on; When use HDMI cable, switch the TV input to HDMI input;



For more information regarding this Patriot
5 EZ Handheld/Stand Smart Magnifier
or any of our other Patriot brand of
innovative low vision products, we invite
you to visit us
at:

Website: www.patriotvision.com

For question or support, please contact us at:
800-364-1608 / 352-203-4164
Fax: 352-203-4617
Email: info@patriotvision.com

Patriot Vision Industries, LLC, is an affiliate of Low VisionAids, Inc. Patriot, Magnifying America, the words and their symbols/logo/mark are licensed trademarks owned by Low VisionAids, Inc.

Copyright 2024. All Right Reserved. Designed in the USA.
Please be advised that this user guide may contain errors, and is therefore subject to being changed or updated without prior notice.